

Operating Instructions

Color Video Medical Monitor

Model No. **MT-M1980**



Panasonic®

Read these instructions completely before operating this unit.

TQB 510190

Dear Panasonic Customer:

Welcome to our Panasonic family of customers. This Color Video Monitor is for use in medical facilities under the direction of a trained physician. This instruction booklet provides all the necessary operating information. However, in this instruction, clinical techniques are not mentioned. Clinical aspects must be approached from a professional viewpoint.

We hope that you will be pleased with your Panasonic Color Video Monitor.

The serial number of this product may be found on its back. You should note the serial number of this unit in the space provided and retain this book as a permanent record of your purchase to aid in identification in the event of theft or loss.

Model number: **MT-M1980**

Serial number: _____

Contents

Important Safety Notice	2	Operation of Rear Terminals	7
Precautions	3	Connections	9
Preparations	4	Specifications	12
Operation of Front Panel Controls	5		

Features

- **Overscan function**
Display size selectable original size/increased size using a single switch.
- **4 color systems**
This unit can accept four standards: NTSC, M-NTSC, PAL, SECAM.
It automatically switches into the appropriate color system.
- **High horizontal resolution of more than 700 lines.**
- **Comb filter**
This filter has been adapted from broadcast quality monitors for maximum screen resolution.
- **Automatic White Balance circuitry for stable color reproduction**
- **Abundant input/output terminals**
RGB, S-Video and Composite video signal terminals. Each of the input terminals is equipped with a loop-through output terminal for easy connection of additional equipment.
- **Built-in speaker (1.5W output power)**
- **Metal hybrid cabinet for rugged construction**
- **Providing the cord guard for safety reason**

IMPORTANT SAFETY NOTICE

WARNING: To prevent damage which may result in fire or shock hazard, do not expose this appliance to rain or moisture.

Power Supply: This Color Video Monitor is designed to operate on 120 volts 50/60Hz, AC house current only.



CAUTION

RISK OF ELECTRIC SHOCK
DO NOT OPEN



CAUTION: TO REDUCE THE RISK OF ELECTRIC SHOCK,
DO NOT REMOVE COVER (OR BACK)
NO USER-SERVICEABLE PARTS INSIDE
REFER SERVICING TO QUALIFIED SERVICE PERSONNEL



The lightning flash with arrowhead within a triangle is intended to tell the user that parts inside the product are a risk of electric shock to persons.



The exclamation point within a triangle is intended to tell the user that important operating and servicing instructions are in the papers with the appliance.

Power Supply Cord

This Color Monitor is equipped with a three prong grounding-type hospital grade power plug.

This plug will only fit a hospital grade receptacle.

This is a safety feature. If you are unable to insert the plug into the outlet, contact an electrician.

Do not defeat the purpose of the grounding plug.

Remove the plug from the hospital grade receptacle when this monitor is not in use for a prolonged period of time.

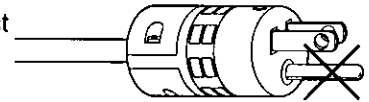

Do not remove



Note:

1. This Monitor meets UL medical and dental equipment standard, UL544.
2. This Monitor qualifies as patient care equipment and is intended for use in a hospital or related health care facility. It is intended for use in displaying information from patient monitoring or data collecting equipment which isolates it from the patient. It is not intended to be connected directly to the patient. (Leakage current: AC 100 microamperes RMS maximum)

WARNING: This equipment has been tested and found to comply with the limits for a Class A digital device, pursuant to Part 15 of the FCC Rules. These limits are designed to provide reasonable protection against harmful interference when the equipment is operated in a commercial environment. This equipment generates, uses, and can radiate radio frequency energy and, if not installed and used in accordance with the instruction manual, may cause harmful interference to radio communications. Operation of this equipment in a residential area is likely to cause harmful interference in which case the user will be required to correct the interference at his own expense.

CAUTION: Any unauthorized changes or modifications to this equipment would void the users authority to operate.

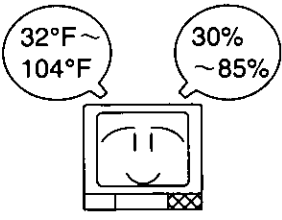
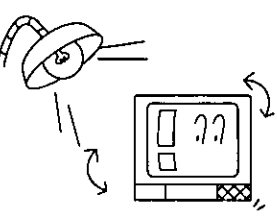
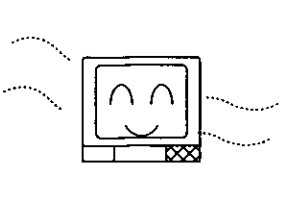
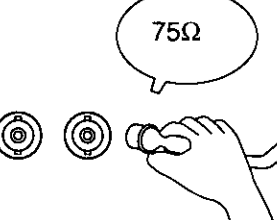
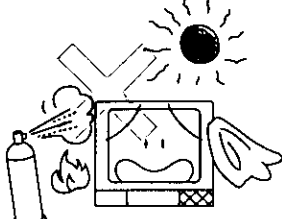
Precautions

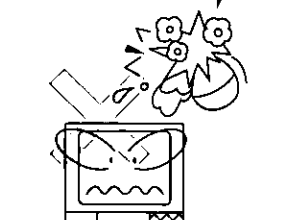
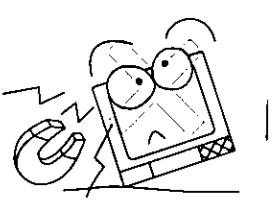
	<p>Do not use and store this monitor beyond its temperature and humidity range.</p> <p>Temperature 32°F~104°F (0°C~+40°C)</p> <p>Humidity 30%~85%</p>		<p>Generally adjust lighting and monitor position to minimize undesirable reflections.</p>
	<p>The monitor should not be operated within an enclosed or poorly ventilated area. This may cause premature component failure. Do not block the ventilation slits on the sides and rear panels.</p>		<p>75 ohm coaxial cable must be used and the correct termination provided to assure good picture quality. Cable attenuation should also be considered on long cable runs and adequate video signal levels made available.</p>
	<p>Do not install where there is a risk of flammable gases. Position the monitor to avoid direct sunlight on the picture tube.</p>		<p>Do not touch electric terminals directly with your fingers. Do not open the cabinet. Refer servicing to qualified personnel only.</p>
	<p>Do not allow liquid to enter the unit. Do not expose terminals and connections to liquids.</p>		<p>Do not install in a place mechanical vibration or shock, or magnetic. Do not hit or shake this unit when moving it. This may cause damage.</p>

Care and Storage

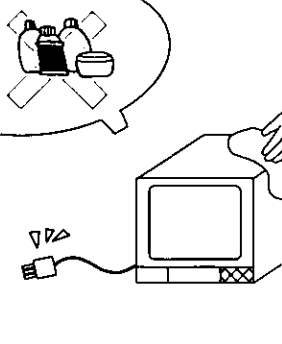
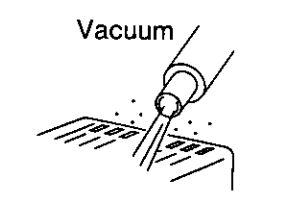
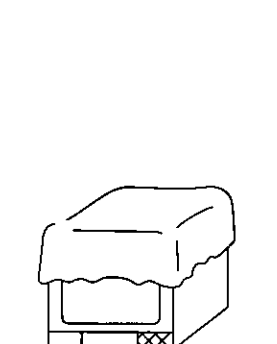
 <p>Vacuum</p> 	<p>Care:</p> <p>Wipe with a soft cross and neutral detergent mixed with water. Do not contact with volatile substances or adhesives.</p> <p>Turn the power switch OFF while cleaning. Before turn ON, surface must be dry.</p> <p>Cleaning Ventilation Slits:</p> <p>When dust has accumulated, use a vacuum cleaner.</p>		<p>Storage:</p> <p>Disconnect all the connected cables and cords. Cover with a vinyl cover. Do not subject to impact.</p> <p>Do not subject power or video cables to excessive strain or bending.</p>
---	---	--	--

Preparation

Connecting to the Power Supply

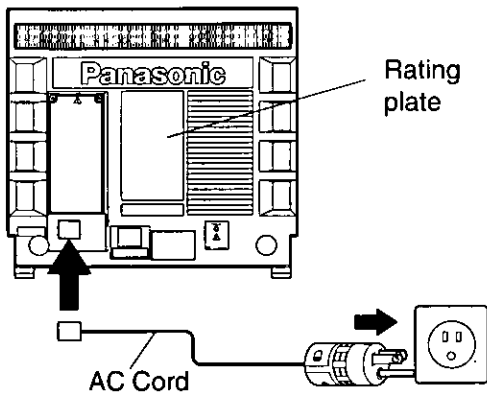

Check rating plate and power supply.
Connect the AC cord to a **hospital grade receptacle**.

Caution:

As safety is impaired do not connect to a table tap outlet.
Do not use a 3-pin to 2-pin conversion adapter plug.
To disconnect the plug, pull it out by plug.
Never pull the lead.

No excessive bending, straining or squeezing forces are applied to the AC cord.

Wind as shown in below when the AC cord is not in use.

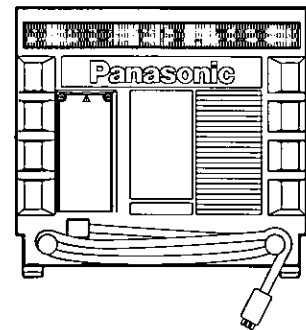

Rack Mount Handle Installation

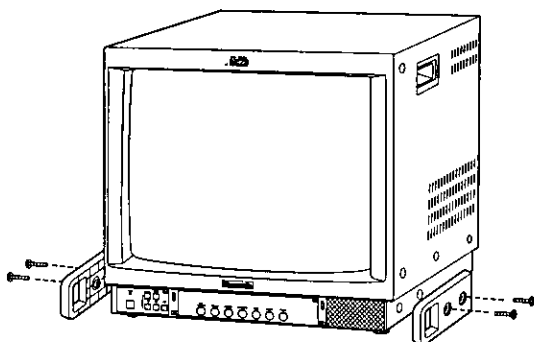

Fit on the side of this unit and fix it with 4 screws (included).
Use the Philips head driver.

Front Cover Installation

The cover for front controls is included with this monitor.
Install the cover to prevent unexpected changes of the adjustments.

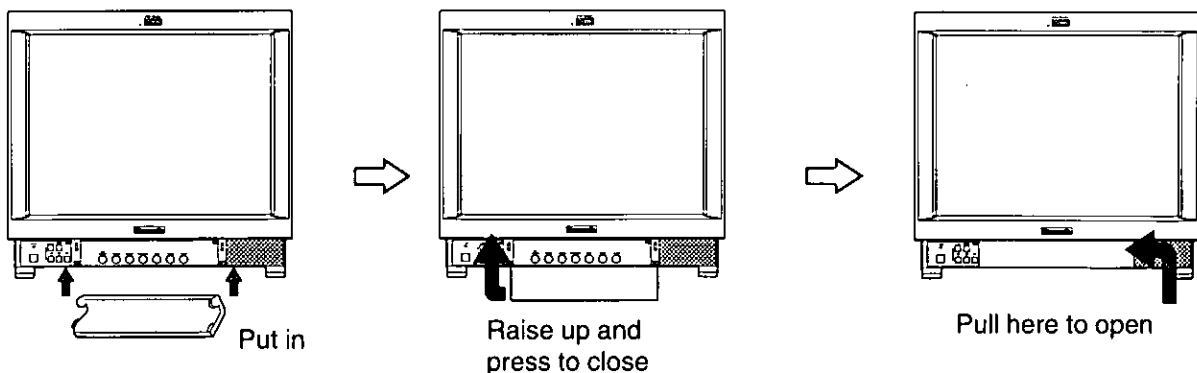

Before Using this Monitor

- Check the AC cord is connected properly.
- Check the input terminals and corresponding units are connected properly. (refer to page 9~11)

Operation of Front Panel Controls

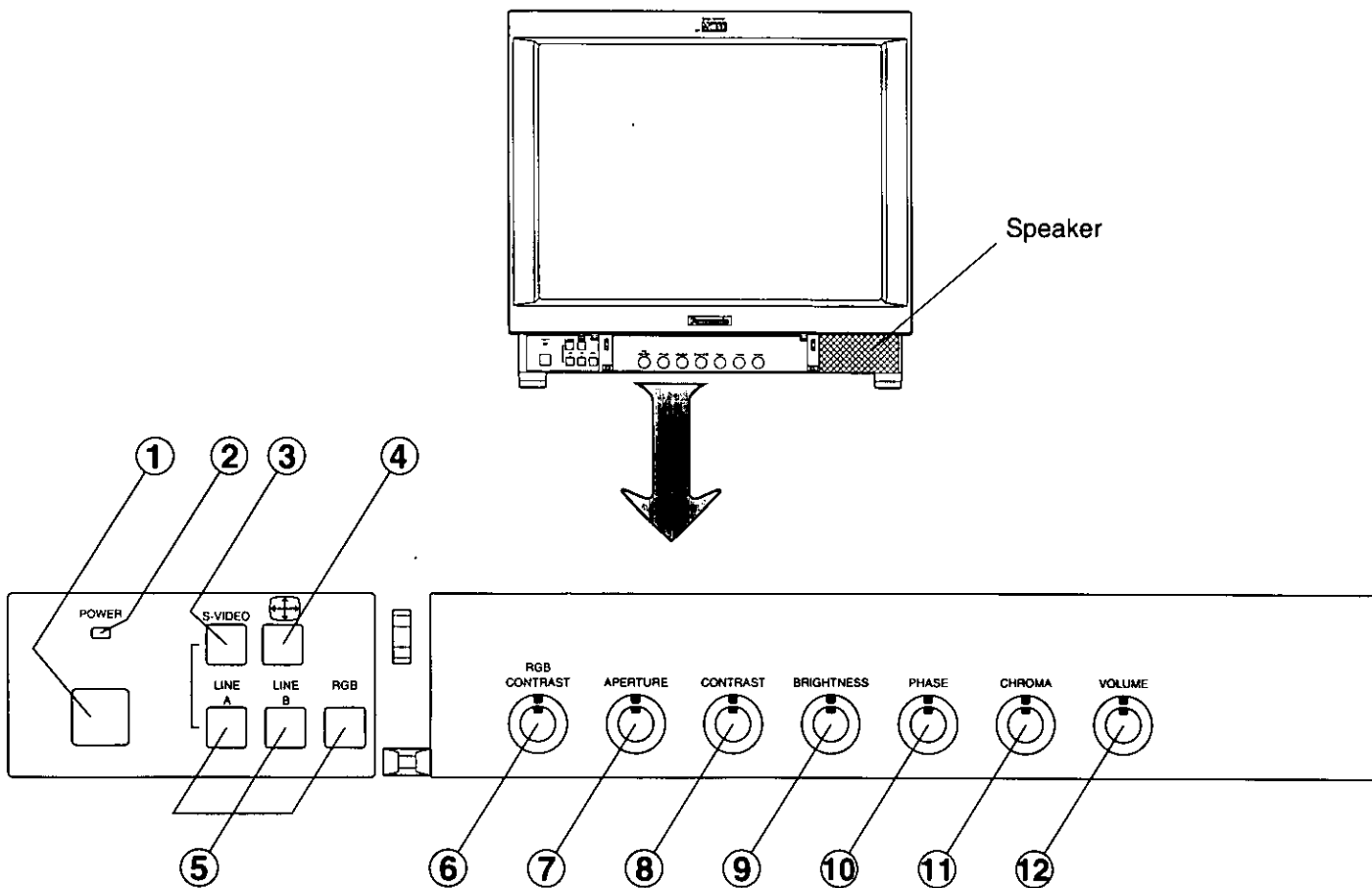

① **Power Switch**
Press to turn the Color Monitor ON/OFF.



② **Power Indicator**
This indicator will light when the power is ON.

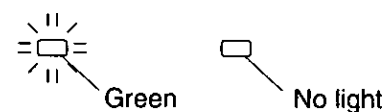

③ **S-VIDEO Switch**
Press to determine which terminal will be selected when the Line A input is switched on.

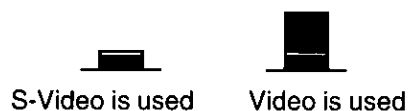

④ **Overscan Switch**
Press to increase the display size (approximately 117%).
To return its original display size, press this switch again.

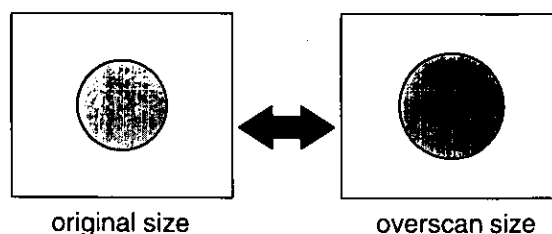

⑤ **Input Selector Switches**

Three signal inputs (LINE A/LINE B/RGB) can be selected.

⑥ **RGB Contrast Control (for RGB)**

Adjust the contrast level for the desired overall contrast.

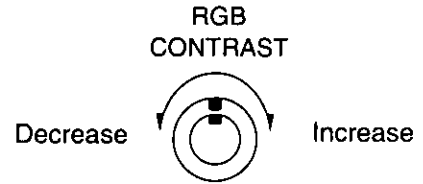

⑦ **Aperture Control (for LINE A/LINE B)**

Adjust the aperture control for the picture sharpness. This function is ineffective at RGB input.

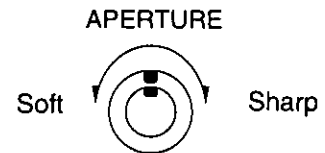

⑧ **Contrast Control (for LINE A/LINE B)**

Adjust the contrast level for the desired overall contrast.

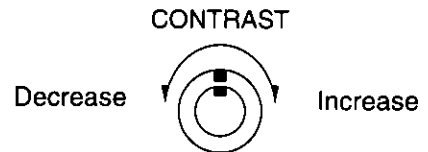

⑨ **Brightness Control**

Adjust the brightness level for the desired overall picture or display brightness.



⑩ **Phase Control (for NTSC/M-NTSC)**

Adjust the phase control for the proper color phase or flesh tone tint.

This function is ineffective at RGB input.

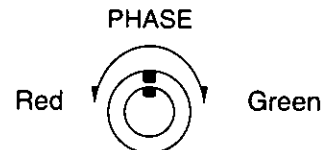

⑪ **Chroma Control (for LINE A/LINE B)**

Adjust the chroma control to set the color saturation level. This function is ineffective at RGB input.

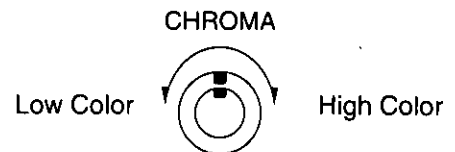

⑫ **Volume Control**

Adjust the control for the appropriate audio level.

If the audio section is not used, turn to minimum position.

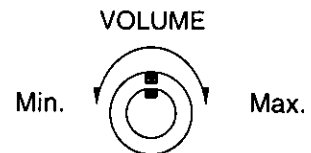

Operation of Rear Terminals

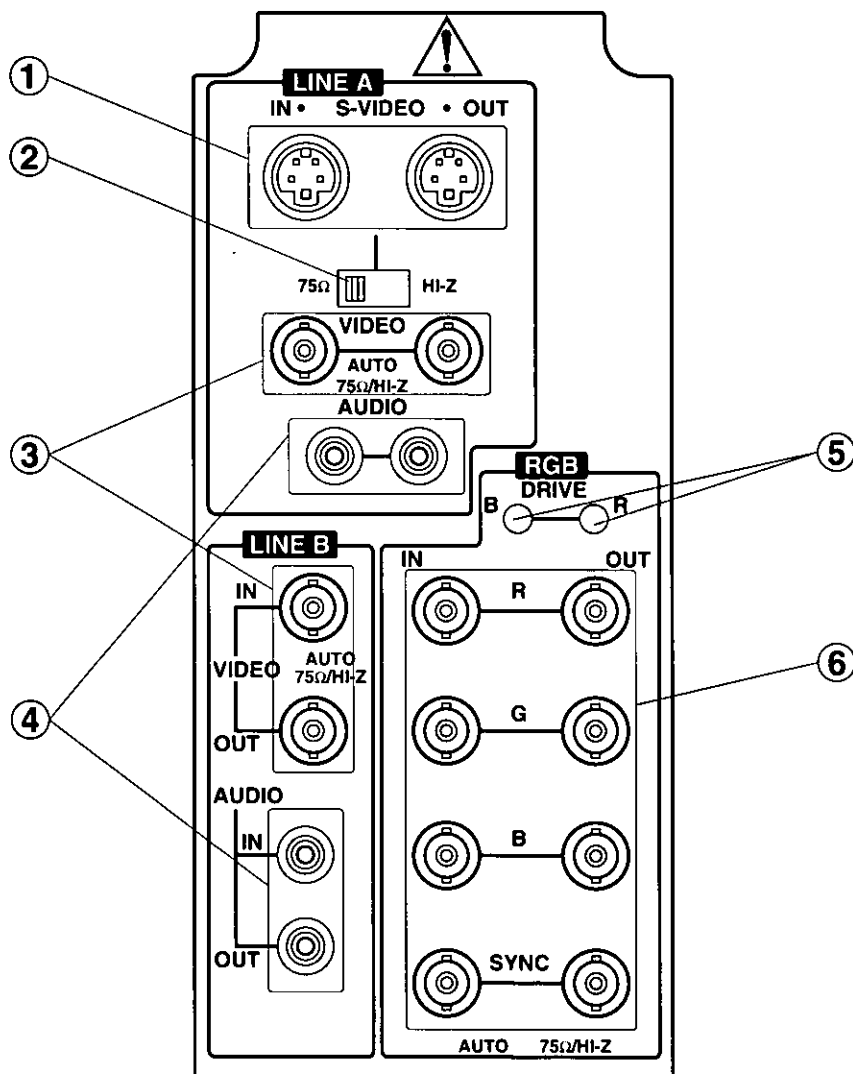
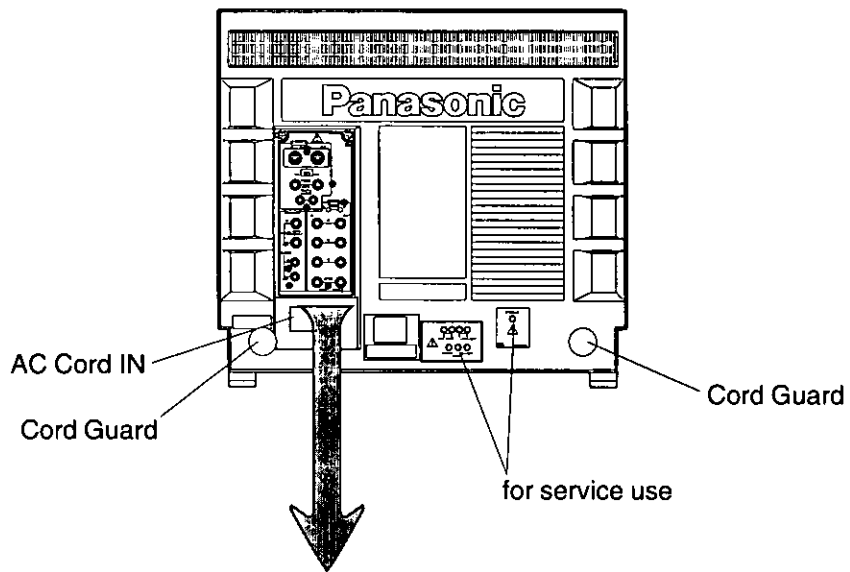

① **S-Video Input/Output Terminal (4pin)**

Luminance signal and chroma signal input/output terminal.

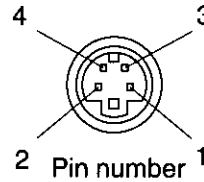

Pin No.	Function
1	GND (Luminance)
2	GND (Chroma)
3	Luminance
4	Chroma

② **S-Video Impedance Switch**

Set this to HI-Z when the S-VIDEO output terminal is used. Set it to 75Ω when just the S-VIDEO IN terminal is used.

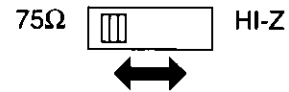

③ **Video Input/Output Terminals (BNC)**

These terminals are for use of Video signals come from video equipment.

When BNC connectors are connected into IN and OUT terminals, the 75Ω termination will be automatically opened.

④ **Audio Input/Output Terminals (RCA phono)**

These terminals are for use of Audio signals come from video equipment.

⑤ **RGB White Balance Adjusters**

For service use.

⑥ **RGB Input/Output Terminal (BNC)**

These terminals are for use of R,G,B signals and synchronize signal.

When BNC connectors are connected into IN and OUT terminals simultaneously, the 75Ω termination will be automatically opened.

Note:

Depress the S-VIDEO switch on the front panel to select the S-Video terminal when the Line A input is switched on.

Connections

1. Video (BNC) Terminal

Line A

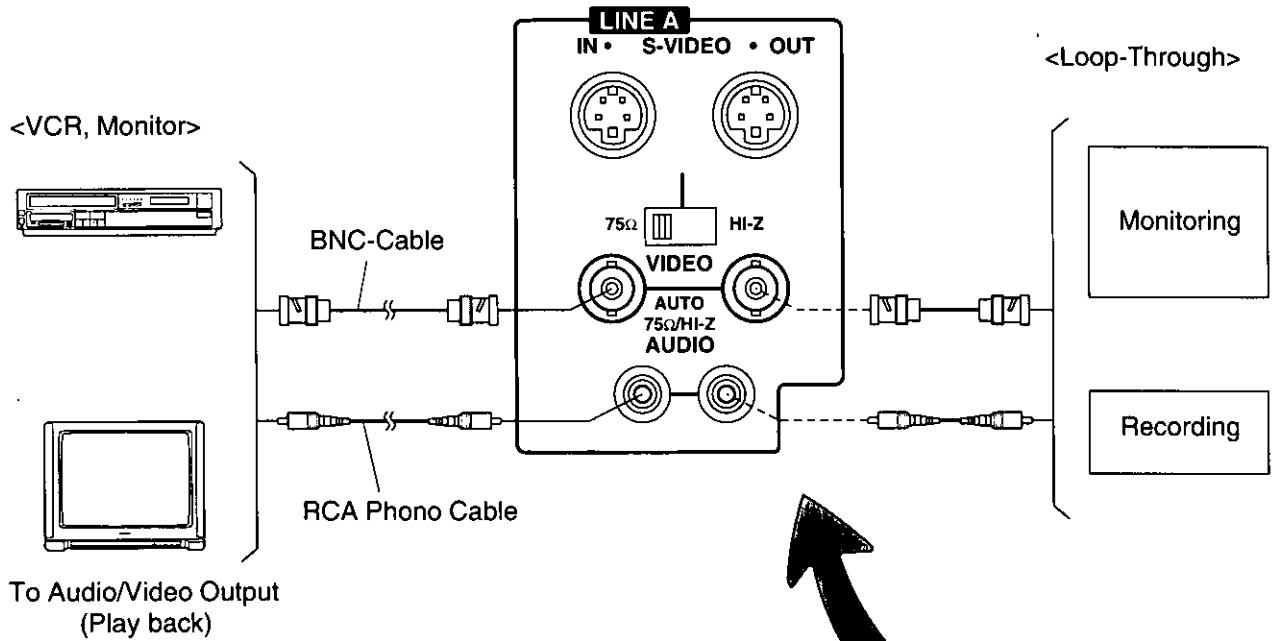

Line B

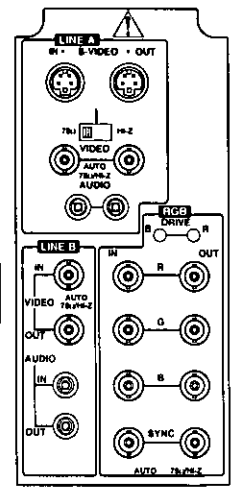
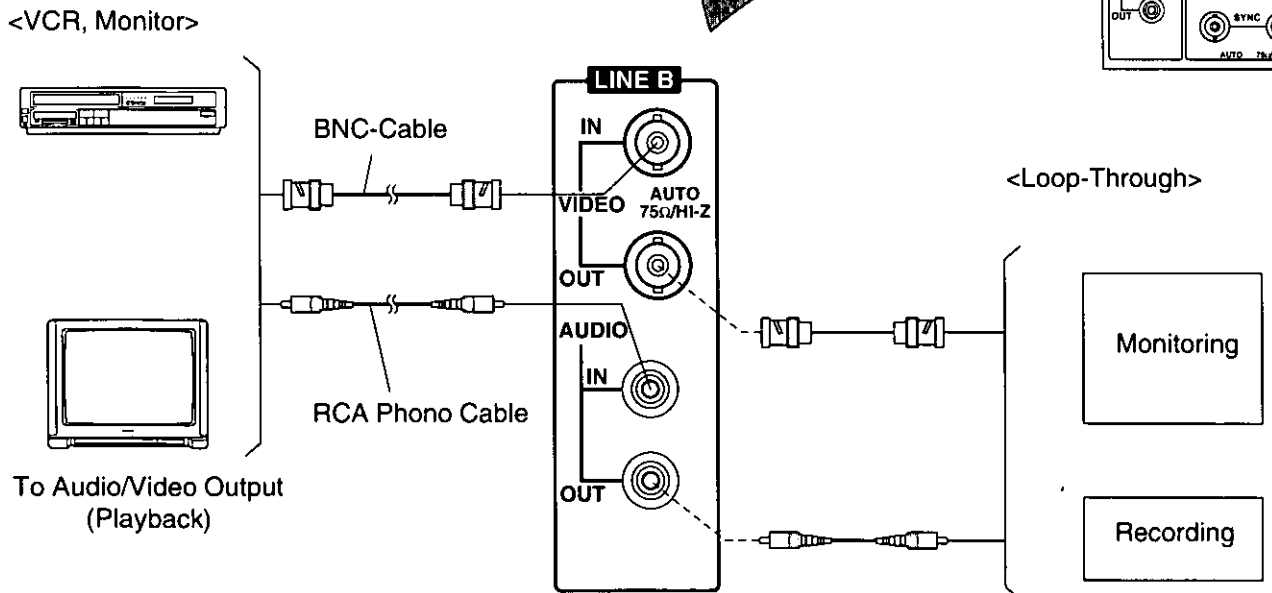

2. S-Video Terminal

<VCR with S-VIDEO terminal>

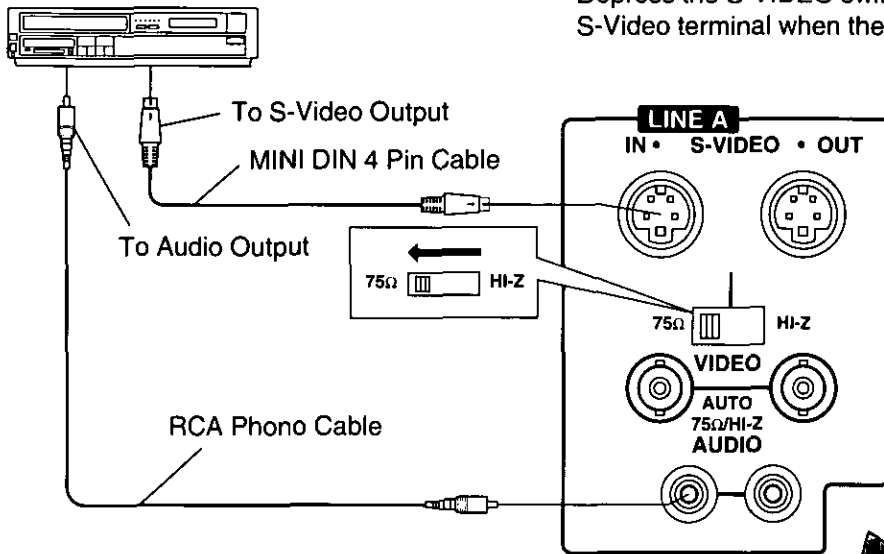

Note:

Depress the S-VIDEO switch on the front panel to select the S-Video terminal when the Line A input is switched on.

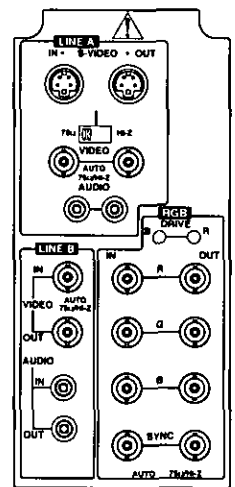

S-Video Loop-Through

<VCR with S-VIDEO terminal>

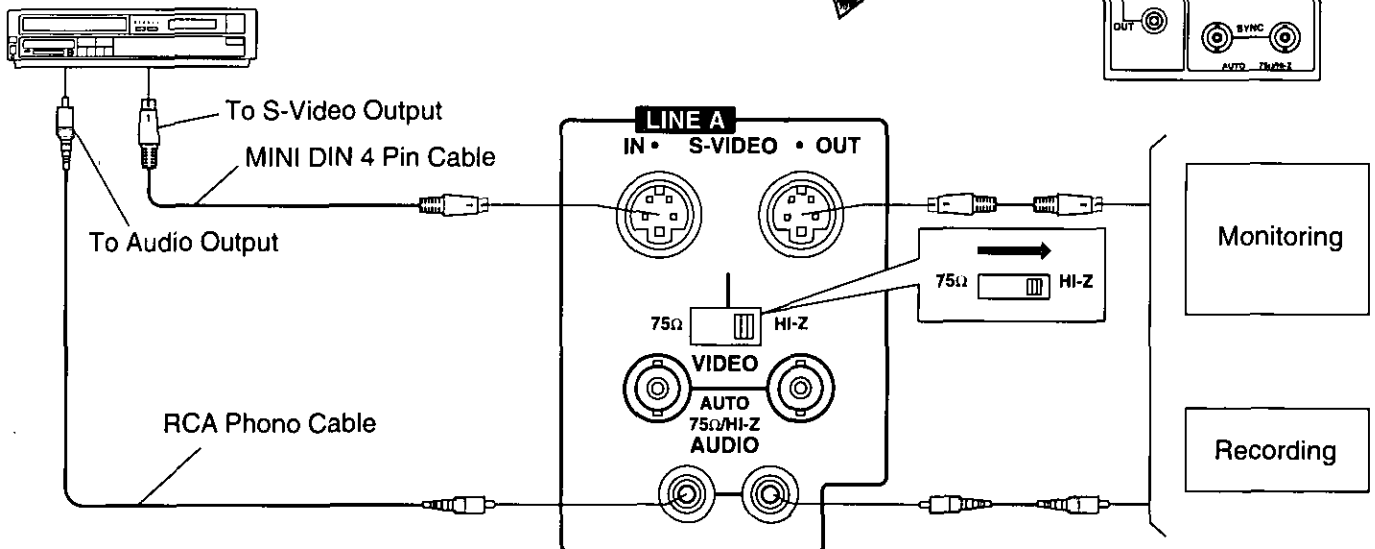

3. RGB Terminal

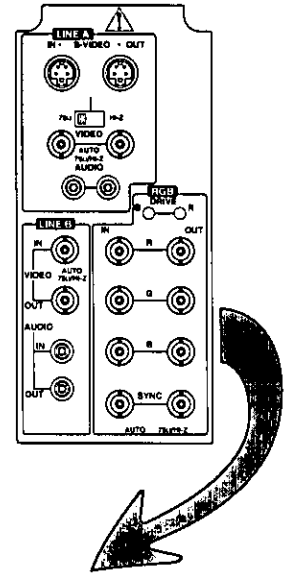

<RGB signal source>

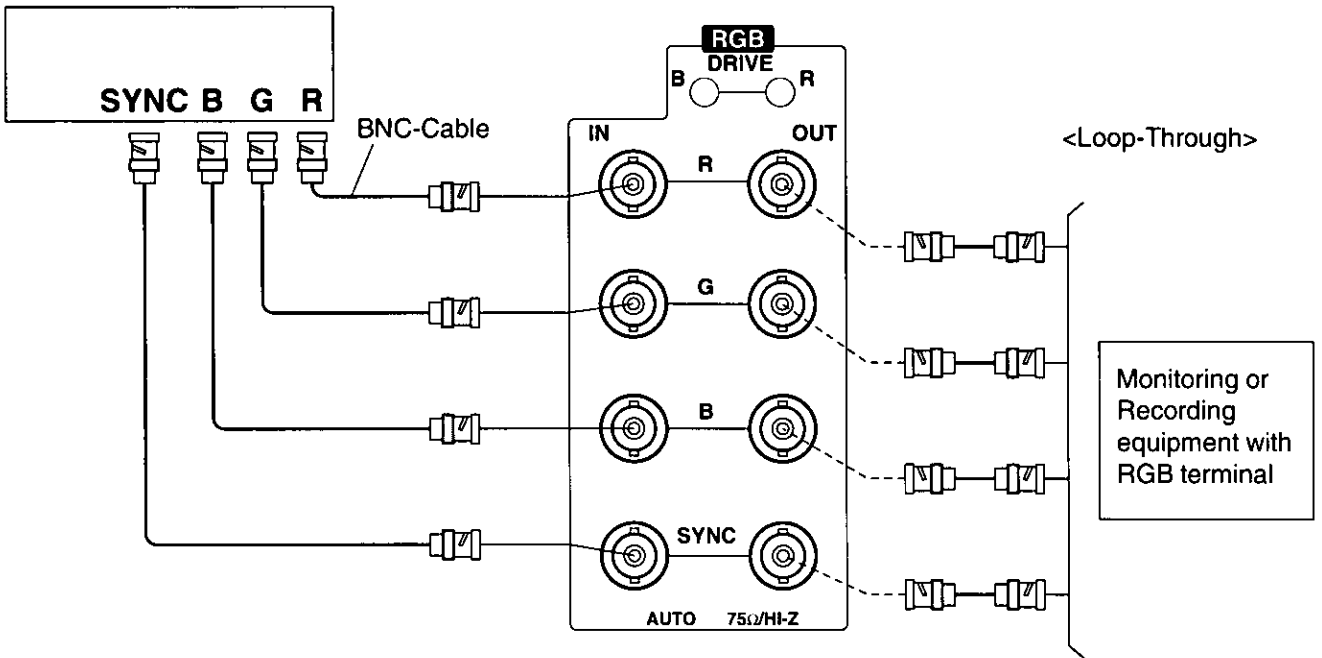

Specifications

Power Source:	AC120V 50/60Hz	Resolution:	more than 700 TV lines (Horizontal)
Power Consumption:	96W	Color Temperature:	6500K
Picture Tube:	19" Diagonal 90-degree deflection 0.40mm Dot Pitch	Dimensions:	
Speaker Output:	1.5W	Width	448mm (17-11/16 inches)
Video/Audio Terminals: (LINE A/LINE B)		Depth	532mm (21 inches)
Video Input;	1.0Vp-p, 75Ω or HIGH impedance (Auto), BNC type connector	Height	414mm (16-5/16 inches)
Video Through Out;	Automatic Termination Opener, BNC type connector	Weight:	27.5kg
Audio Input;	0.5Vrms, 22kΩ or more, phono type connector	Operating Temperature:	32°F~104°F (0°C~+40°C)
Audio Through Out;	Phono type connector	Operating Humidity:	30%~85%
S-Video Input;	Y signal 1.0Vp-p, C signal 0.285Vp-p, 75Ω or HIGH impedance (Manual), MINI DIN 4P type connector	Accessory:	AC Power cord Front cover Rack Mount Handle (2) Screw for Rack Mount Handle (4)
S-Video Output;	Y signal 1.0Vp-p, C signal 0.285Vp-p, 75Ω or HIGH impedance (Manual), MINI DIN 4P type connector		
RGB Terminals:	R; 0.7Vp-p±2dB 75Ω with automatic loop-through output BNC type connector (2) G; 0.7Vp-p±2dB 75Ω with automatic loop-through output BNC type connector (2) B; 0.7Vp-p±2dB 75Ω with automatic loop-through output BNC type connector (2) Sync; 4.0Vp-p \pm_{-26}° dB negative, 75Ω with automatic loop-through output, BNC type connector (2)		

◆ Specifications are subject to change without notice.

Memorandum

Memorandum

Panasonic®

Professional/Industrial Video

Panasonic Broadcast & Television Systems Company
Division of Matsushita Electric Corporation of America

HEADQUARTERS:

50 Meadowland Parkway, Secaucus, New Jersey 07094

EASTERN ZONE:

50 Meadowland Parkway, Secaucus, NJ 07094 (201) 348-7620

CENTRAL ZONE:

9041 West Grand, Ave. Franklin Park IL 60131 (708) 452-2280

SOUTHERN ZONE:

Dallas Region: 4500 Amon Carter. Blvd., Ft Worth, TX 76155 (817) 685-1117

Atlanta Region: 1854 Shackleford Ct., Suite 115, Norcross, GA 30093 (404) 717-6841

WESTERN ZONE:

Seattle Region: 1200 Westlake Ave. N., Suite 508, Seattle, WA 98109 (206) 285-8883

Los Angeles Region: 6550 Katella Ave., Cypress, CA 90630 (714)373-7275